



**CBX-1**  
**Chatbox Single**  
tech specs

**CHATBOX** BY SILEN



# Every office deserves a Chatbox

For deep work, private calls, or a creative session.

## Increase your productivity by 25%

### Soundproof

Keep your conversations private while keeping background noise out.

### Made by Silen

Made by the team behind Silen Space, the Chatbox is a simplified version of their most popular phone booth, leaving only the essential purpose in its simplest functional form.

### Ventilation

Chatbox uses a technology that keeps the booths ventilated, ensuring fresh air throughout your time spent inside.

### Quick assembly

It takes about 30 minutes for two people to assemble – and you only need one tool.

## Simple assembly, simple choices

### Dark beauty

Black offers a striking visual accent and attracts attention.

### Left and right-handed door in one

You can change the door position at any time.



### Bright oasis

White is an elegant and unobtrusive choice for light-toned rooms.

### Accessories? Check.

Whiteboard and screen brackets with cable management are available for Chatbox.

## Your new normality

### Single

A space to focus on your own or make uninterrupted phone calls.

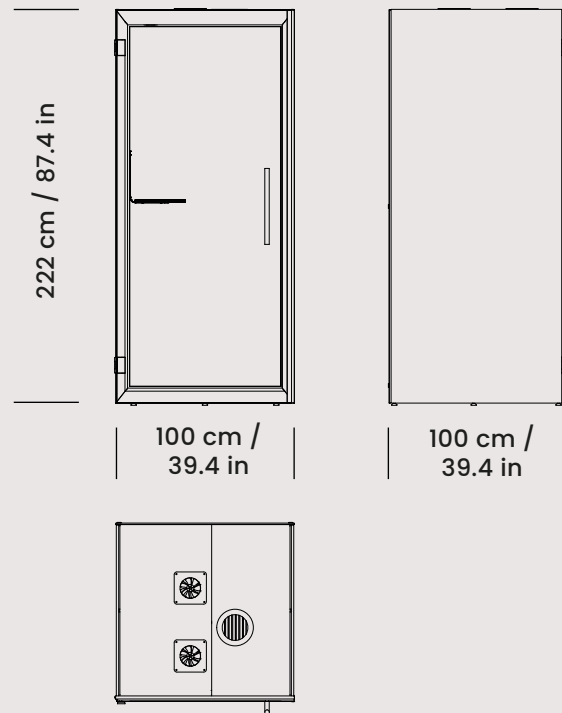

## A silent space for creativity to flourish

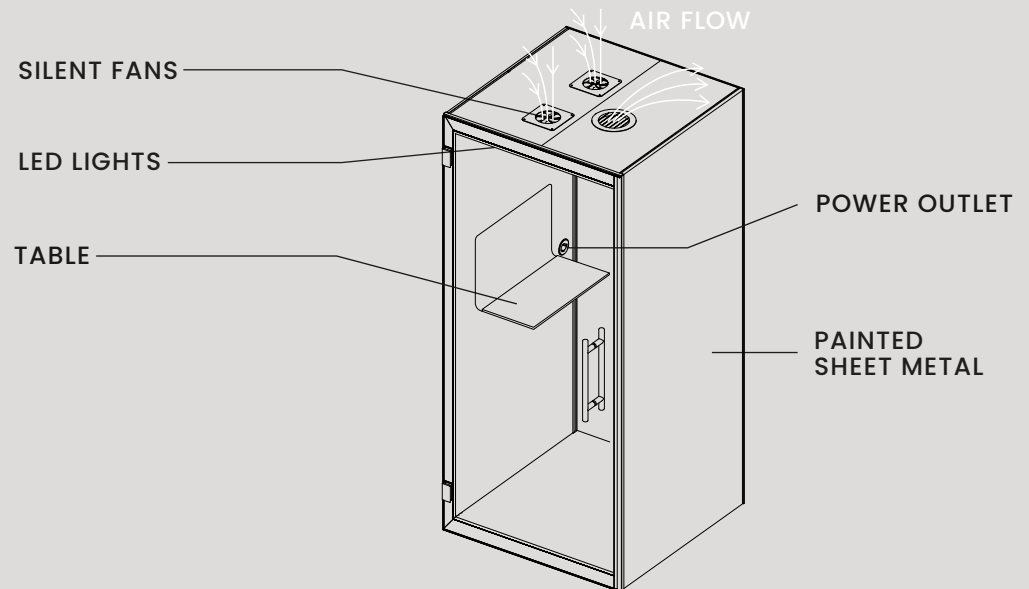

### Affordable, yet sleek

Direct from our warehouse to you, Chatbox is shipped flat-packed, making it more affordable than other phone booths.

### 2 people + 30 min + 1 tool









No installer needed to set up Chatbox. Just ask a friend for some help. Done!

### Durable means sustainable

Well thought-out form, construction, and choice of material allows for extended durability. In addition, easy assembly and disassembly allow you to take it to your next office space.

## Single Tech specs

### GENERAL PRODUCT INFO

|                                 |   |   |
|---------------------------------|---|---|
| <b>Exterior size</b><br>(W×H×D) | 100 × 222 × 100 cm<br>39.4 × 87.4 × 39.4 in   |   |
| <b>Interior size</b><br>(W×H×D) | 87 × 204 × 98 cm<br>34.2 × 80.3 × 38.6 in   |   |
| <b>Weight (net)</b>             | 330 kg / 727.5 lbs  |   |
| <b>Sound reduction</b>          | 34 db (on-site measurements in accordance with ISO 16283-1)   |   |
| <b>Door position</b>            | left and right-handed door in one   |   |
| <b>Exterior colors</b>          | Stocked finish:<br> Black (RAL9011) <b>-K</b><br><br>Made-to-order finish:<br> White (RAL9003) <b>-WH</b> | Colour collection for additional price:<br> Mint Turquoise (RAL6033) <b>-MT</b><br> Chrome Green (RAL6020) <b>-CG</b><br> Ochre Yellow (RAL 1024) <b>-OL</b><br> Quartz Grey (RAL 7039) <b>-QG</b><br> Red Violet (RAL 4002) <b>-RV</b><br> Sapphire Blue (RAL 5003) <b>-SB</b> |
| <b>Interior color</b>           | dark grey   |   |
| <b>Air ventilation</b>          | low consumption air circulation system (max 3.4 W)  |   |
| <b>Air flow</b>                 | air circulation speed is more than 22 l/s (79 m <sup>3</sup> /h) (47 ft <sup>3</sup> /min)  |   |
| <b>Lighting</b>                 | energy-efficient LED light (6.7 W, 4,000 K, 900 lm)   |   |
| <b>Power outlets</b>            | 1 x UK socket & 1 x USB port  |   |
| <b>Power lead</b>               | 3 m / 9 ft 10 in  |   |
| <b>Exterior material</b>        | painted sheet metal   |   |
| <b>Glass</b>                    | sound control laminated safety glass  |   |
| <b>Floor</b>                    | antistatic and stain resistant low loop pile carpet for public spaces, EN 1307  |   |
| <b>Acoustic surfaces</b>        | acoustic EchoFree panel   |   |
| <b>Adjustable feet</b>          | for easy levelling from inside the booth  |   |
| <b>Table</b>                    | built-in table with antibacterial laminate finish, 700 × 300 × 132 mm / 28 × 12 × 5,2 in  |   |

## Furnishing Options

### GENERAL PRODUCT INFO

---

**Video Call Set** Mount a display for video calls & add a stool for increased comfort

---

**Screen bracket** Universal bracket in accordance with VESA standard, for up to 24" screen (screen not included)

**Stool** Fundamental stool in beech



---

**Accessories** Charge your devices or make notes on a conference call

---

**Whiteboard** Magnet laminate surface  
700 x 750mm



**Dams Furniture Ltd**  
Charley Wood Road,  
Knowsley Industrial Park,  
Knowsley,  
Merseyside  
L33 7SG

0151 548 7111  
sales@dams.com  
www.dams.com